

The
TOTAL SOLUTION[®]
In Power Steering

**EDELMANN
ELITE**

**PLEWS &
EDELMANN**

EDELMANN[™]



For more information on all our product lines, visit us at: www.plews-edelmann.com

For a complete listing of our products by application, including VIN look-up, check out our catalog at: plews.mycarparts.com

TABLE OF CONTENTS

4	Power Steering Total Solution
6	Power Steering Hard Parts
10	Power Steering Coolers
16	Universal Power Steering Filter
18	Premium Synthetic Power Steering Fluid
20	High Performance Power Steering Hoses
22	Legacy Power Steering Hoses
24	Power Steering Repair Kits
25	Turbocharger Oil Lines
26	Edelmann Analytics
28	North American Supply Chain
30	Warranty

Power Steering Total Solution®



A complete and thorough power steering repair is of utmost importance whenever a power steering component requires replacement

The power steering system plays a crucial role in ensuring smooth and controlled vehicle maneuverability, making it imperative to address any issues promptly and effectively. By addressing power steering pumps, racks and gears, hoses, coolers (where applicable), filter, and fluid in a comprehensive manner, technicians and users can ensure optimal performance, safety, and longevity of the power steering system. Neglecting any

aspect of the repair process may lead to diminished steering control, increased wear and tear, and potential system failures. Prioritizing a meticulous approach will result in satisfied customers and vehicles that offer a smooth and effortless driving experience. Warranty returns are most likely to occur because a complete power steering repair was not performed. **Edelmann Elite® products offer everything needed to do the complete repair, every time.**



Hard Parts

The power steering pump is vital, supplying fluid for effortless steering. Thoroughly inspect and replace if needed for peak performance. Neglecting this results in less assistance, harder steering, and possible damage.

The power steering rack or gear transmits hydraulic power from pump to wheels, translating driver's input. When changing system parts, complete repair is crucial for precise control. Inadequate fixes lead to play, erratic response, and safety risks.

Hoses

Power steering hoses are crucial for fluid transport between the pump, rack, and other components. When replacing one, inspect the entire assembly, including fittings, for leaks, cracks, or wear. Neglecting this may cause leaks, pressure loss, and compromised steering.

Cooler

Certain vehicles have power steering coolers to dissipate operational heat, maintaining fluid temperature within the ideal range. When fixing the power steering, assess cooler condition for proper cooling. Skipping this risks overheating, fluid breakdown, and early component failure.

Filter

Power steering filters trap debris in the system, safeguarding sensitive components from damage. In a thorough repair, inspect and replace the filter as needed. Skipping this step speeds up wear, reduces flow, and raises the risk of system failure.

Fluid

Power steering fluid enables effortless steering. In complete repairs, flush and replace it, eliminating contaminants for top performance. Skipping this leads to reduced assistance, higher wear, and possible malfunctions.



NEW Hard Parts

REDUCE WARRANTIES

Upgrade your power steering inventories with the Edelmann Elite® power steering hard parts program. This revolutionary line of racks, pumps, and gearboxes is a cut above the rest, setting new standards in quality, performance, and reliability. Built to **exceed original equipment (OE) specifications**, Edelmann Elite offers an unparalleled level of precision, ensuring a perfect fit, impeccable form, and seamless functionality.

The DNA Advantage

One of the standout features of Edelmann Elite is its ability to drastically **reduce warranty claims**. Each and every part in this exceptional lineup receives a unique **Designated Numeric Asset® (DNA)** identification number. This verification system ensures the authenticity of the product and is supported by a comprehensive **100% test inspection report**, included with every purchase. This report confirms the unparalleled level of quality that our parts offer, **guaranteeing peace of mind and eliminating warranty hassles** caused by counterfeit claims, fraudulent part swaps, and untraceable returns.

6038PX 200926103

PART NUMBER

BUILD DATE
(YYMMDD)

DAILY TEST &
BENCH NUMBER

100 YEAR / 1,000,000 MILE WARRANTY

90% SALES
DEMAND
COVERAGE

Designed Better

At Plews & Edelmann®, **we don't just sell parts; we redefine them.** Our commitment is to consistently meet or exceed OE specifications, or even enhance them where necessary. **Every part we offer is 100% brand new**, ensuring maximum performance and eliminating the risk of hidden deterioration. This means **no more core headaches** or dealing with grimy, soiled parts. Experience the future of power steering with Edelmann Elite and discover a new level of precision, reliability, and peace of mind.

Unmatched Coverage

Edelmann Elite offers **application coverage that is unmatched** by other aftermarket power steering hard parts. With a wide range of products available, Edelmann Elite **provides a competitive option over OE dealer sourced parts**, giving you more choices without compromising on quality.



**EDELMANN
ELITE**

Plews & Edelmann® takes attention to detail to a whole new level. Racks, pumps, and gear boxes are meticulously designed, developed, and quality built by Plews & Edelmann. These hard parts not only eradicate commonly experienced failures associated with OE design flaws, but they also go above and beyond by incorporating the latest OE revisions and enhancements. With Edelmann Elite®, you can trust that your power steering catalog is equipped with the most advanced and improved components available.



PUMPS - SIMPLE INSTALL



In many instances in our pump program, we have included either the pulley, reservoir, or pipe, and in some cases, a combination of the three. These are included to simplify the installation process by removing the need for specialized tools and reducing the chance of error or damage to components. We even make it easier to identify components our parts come with by using an easy to understand part numbering system:

R=Reservoir **P**=Pulley **X**=Pipe **U**=Universal

GEARS - IMPROVED DURABILITY



By addressing common issues, such as cracking pistons, our enlarged pistons ensure optimal performance under extreme loads. For heavy-duty applications like towing, our gearboxes feature increased teeth size for improved strength. Additionally, upgraded seals effectively prevent fluid seepage and maintain lubrication, safeguarding the system from debris.



RACKS - WE OWN OUR TOOLING



We have upgraded our rack and pinion assemblies, featuring hex fittings instead of splines for our tie rod ends. The rack shafts have a larger O.D. for enhanced durability, ideal for heavy loads and towing. Metal dust caps replace plastic ones for improved longevity. Bushings are included for seamless installation, especially if replacing worn and corroded parts. Internal venting eliminates external tube damage, reducing warranty failures. Additionally, our packaging has received high praise for its exceptional quality, reflecting our commitment to delivering a first-class product and overall experience.

Magnasteer

Magnasteer uses an electromagnet and permanent magnet attached to the steering rack to vary the amount of steering effort needed based on vehicle speed. Because of how Magnasteer racks are designed, they are notoriously difficult for any manufacturer to offer to the aftermarket, be it reman or new. At Plews & Edelmann, we have overcome these difficulties and developed a line of newly manufactured Magnasteer-style racks for some late model GM vehicles.



OEM
FORM FIT FUNCTION
GENUINE

Edelmann Elite® Power Steering Coolers - the ultimate solution for seamless OE replacement and unmatched performance. Unlike competitors who compromise on design, our coolers maintain exact OE spec with ideal cooling performance. Our innovative single tube construction eliminates failure points, while tube expansion and braising ensures durability. Equipped with essential turbulators, our coolers prevent power steering failures and adhere to prescribed temperature ranges. Upgrade to Edelmann Elite for unmatched quality, performance, and peace of mind.





Proper Fluid Temperature

Turbulators churn the fluid and reduce the flow and pressure across the cooler. Without these turbulators, fluid is passing through the system before being properly cooled and pressures are increased over levels expected for the power steering pump. This device prevents further failures to the power steering system after a cooler replacement.

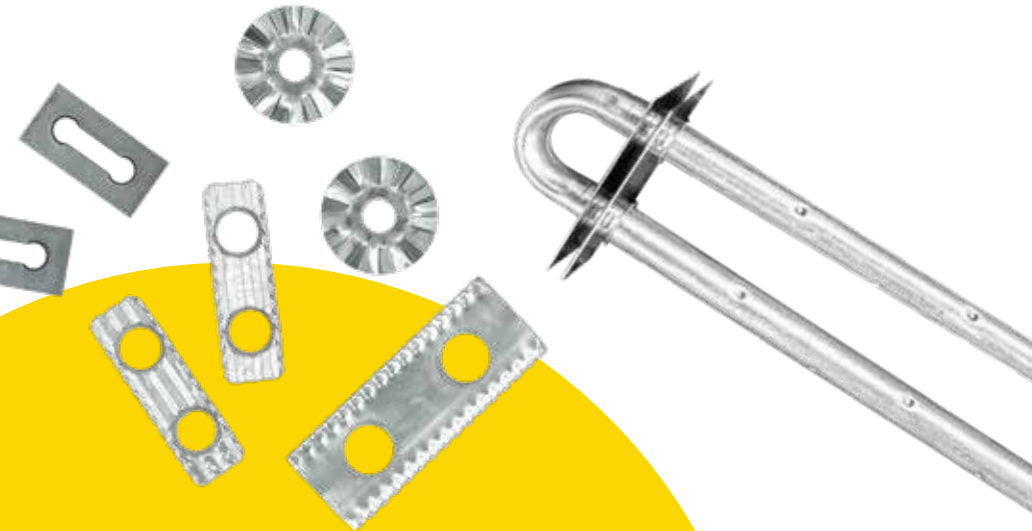

Original Fin Designs

With the OE spec designs, we can provide ideal cooling performance vs our competitors who reduce or reshape the fins to match their redesigned products. Cooling fins additionally serve dual purpose to not only cool the fluid but protect the tubing from flying debris.

Single Tube

Single tube construction is used to prevent the need for additional joints or welds. This prevents leaks and maintains a constant pressure along the entire length of the cooler, allowing the steering system to continue functioning as expected at all times.

100 YEAR / 1,000,000 MILE WARRANTY



Direct Replacement Brackets

Exact match OE bracket designs are used to simplify the installation process. Other aftermarket coolers and some universals have varying designs that don't allow for, or even prevent, installation in the manner designed by the OE. The Edelmann Elite® cooler mounts are designed to install in the exact way in which the OE cooler was removed. Additionally, this ensures that the cooler is positioned correctly to receive the prescribed amount of air flow over the surface of the cooler and without blocking other vehicle components.



Power steering coolers are designed by the OE manufacturer to perform a specific job that differs from vehicle to vehicle. These vehicle specific tolerances are what makes it so important to replace the power steering cooler with as close to an OE match as possible. The Edelmann Elite coolers are designed and built to the genuine OE specifications to ensure performance with exact form, fit, and function to that of the OE unit being replaced.

Universal Cooler

OE QUALITY TO A UNIVERSAL APPLICATION



In applications where the OE has not provided a power steering cooler, Plews & Edelmann® brings OE quality to a universal application. Equipped with sturdy, universal mounting brackets for expert and secure installation virtually anywhere needed, the Edelmann Elite® universal cooler offers a more confident option to the aftermarket.

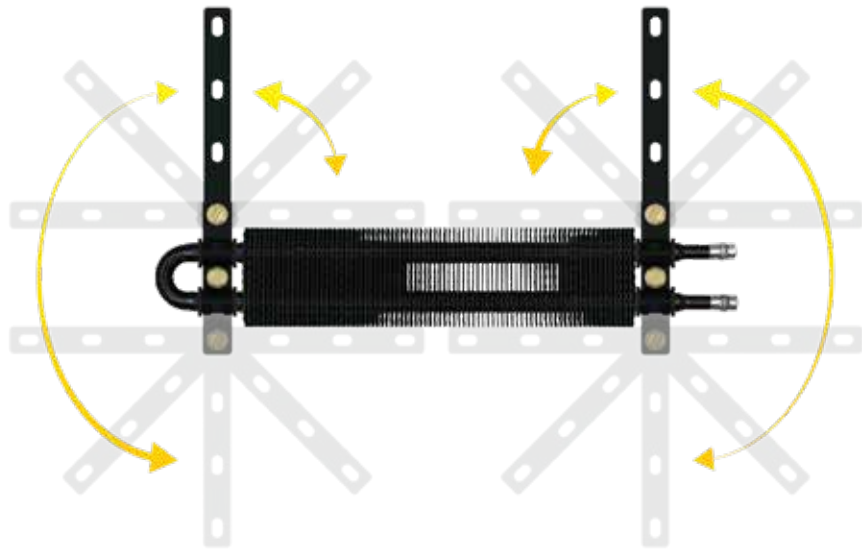
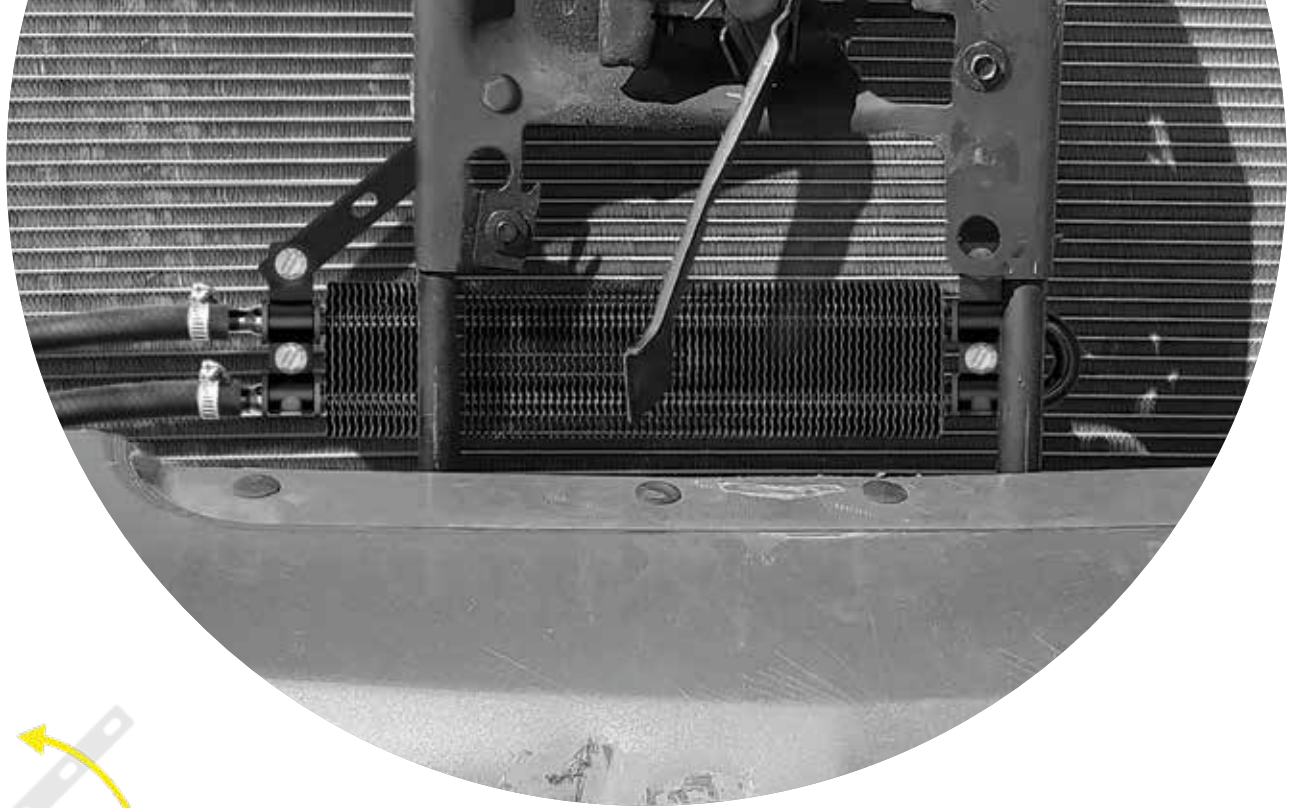

KITS INCLUDE:

- Hoses
- Mounting Hardware
- Hose Clamps



OUTPERFORMS OTHER SIMILARLY SIZED OPTIONS



The single tube design prevents leaks and ensures consistent flow while turbulators churn the fluid to maximize the cooling performance. Our cooler is E-coated after assembly to provide premium corrosion resistance and durability for long product life. Our cooler outperforms other similarly sized options in the aftermarket, ensuring optimal performance every time.

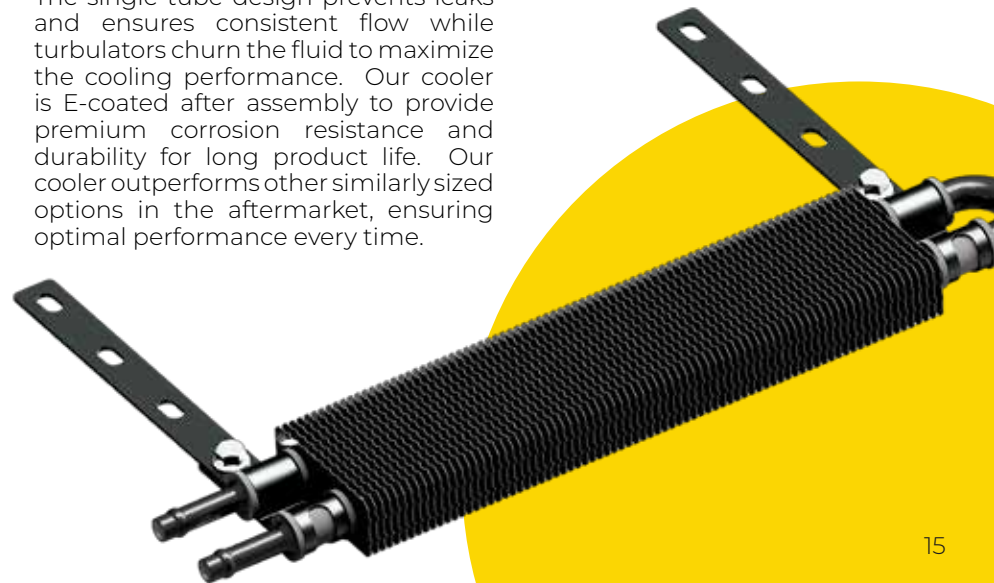

Premium Universal Filter



Part Number: 70699

Case Pack: 6



Patent Pending

Versatility is key with the Edelmann Elite® Universal Power Steering Filter. It's compatible with various hose sizes, thanks to the interchangeable hose barbs. The compact body design ensures a perfect fit in tight engine bays. Whether conducting repairs or maintaining a functional system, adding the Edelmann Elite filter prevents premature failure and keeps vehicles on the road.

Built to last, this filter features durable stainless steel mesh and an aircraft grade anodized aluminum body. The Edelmann Elite filter stands out with its superior dual filtration. The oversized magnet captures and retains metal fragments, providing reliable protection. Its larger filter size allows for three times more efficient removal of particulates and three times the flow rate for smoother power steering operation.

INCLUDES:



End fittings for the right size, every time, without adding skus

UNIVERSAL FITMENT

99%+

VIO Coverage

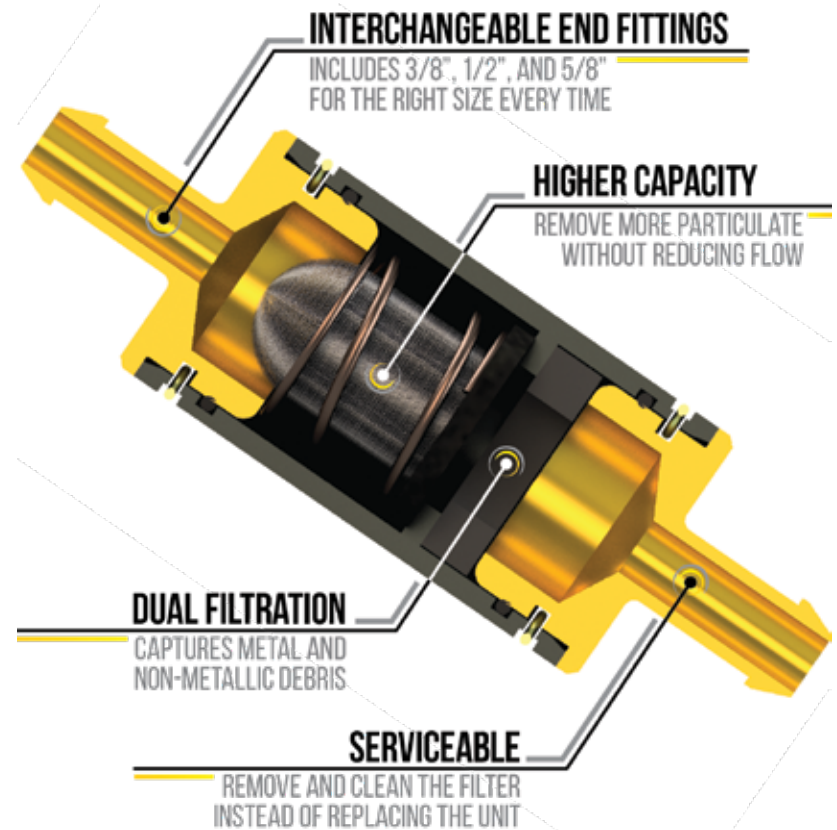

100 YEAR / 1,000,000 MILE WARRANTY



TRUSTED PERFORMANCE AND ULTIMATE PROTECTION



Universal compatibility for foreign and domestic vehicles:

Protects power steering systems with advanced additives, preventing wear, leaks, and corrosion. Withstands extreme temperatures (-58°F to +400°F) for trouble-free operation. Trusted performance and ultimate protection for all power steering systems. Works with all vehicle makes with the exception of Honda/Acura.

UNIVERSAL FULL SYNTHETIC

- Optimum system wear protection:**
 Formulated with synthetic base stocks and advanced additive technology, Edelmann Elite® Synthetic Power Steering Fluid provides excellent wear protection for power steering systems, ensuring trouble-free operation even under severe conditions and extreme temperatures.
- Corrosion and oxidation prevention:**
 This power steering fluid is designed to prevent system corrosion and oxidation, safeguarding power steering pumps and hoses from damage and ensuring long-lasting performance.
- Versatile compatibility and top-off capability:**
 Edelmann Elite Power Steering Fluid is approved and compatible for top-off with all power steering fluids, making it a convenient choice for most foreign and domestic passenger cars and light trucks.



Compatibility & MSDS



Scan Here

Part Number: 70694
Case Pack: 12

HIGH PERFORMANCE POWER STEERING HOSES



CONQUER EXTREME CONDITIONS

Designed with Enhanced Engineering

Edelmann Elite® High Performance Power Steering Hoses — the epitome of power steering hose innovation. Edelmann Elite hoses are engineered for superior durability and performance in all weather conditions. They are constructed with an advanced rubber compound and innovative manufacturing process to create hoses that can withstand years of use without failing. The Elite hoses are extremely durable in hot and cold temperatures, resistant to corrosion, and designed to prevent cracking or swelling issues.

Superior Range

One of the standout features of Edelmann Elite hoses is its superior temperature range performance. No matter the climate, these hoses remain steadfast, providing outstanding impulse durability and stellar cold temperature pliability. Extreme conditions are no match for the Elite power steering hoses, as they are built to thrive in the face of adversity. With this remarkable line of hoses, drivers have the confidence and peace of mind, knowing that their power steering system is well-equipped to handle whatever nature throws its way.

No loss of Form, Fit, or Function

We understand the importance of OEM form, fit, and function, and we remain committed to delivering products that live up to these high standards. Edelmann Elite power steering hoses are no exception. Each hose is meticulously crafted to ensure seamless integration with the vehicle's power steering system, offering the performance and reliability that customers have come to expect from Edelmann® products. The Edelmann Elite line provides coverage to over 130 million vehicles in operation, making it a versatile and trustworthy choice for a wide range of vehicles.

10X

Corrosion Resistance

Edelmann Elite stands out with its outstanding corrosion resistance. These hoses have undergone rigorous corrosion tests and outperformed competitors, lasting ten times longer in environments with water and corrosive agents.

4X

Impulse Durability

Edelmann Elite power steering hoses feature HNBR rubber, tested to 1 million hot cycles and 30,000 cold cycles, surpassing industry standards. Additionally, Elite hoses remain pliable in temperatures below -40°F, allowing confident cold weather start-ups.

2X

Less Swelling

Hose materials absorb fluid and swell and harden, causing cracks to form in the linings of the hose. Edelmann Elite power steering hoses cut oil-induced hose swelling by half, thanks to the upgraded rubber compound, providing extended hose life and preventing premature failure.

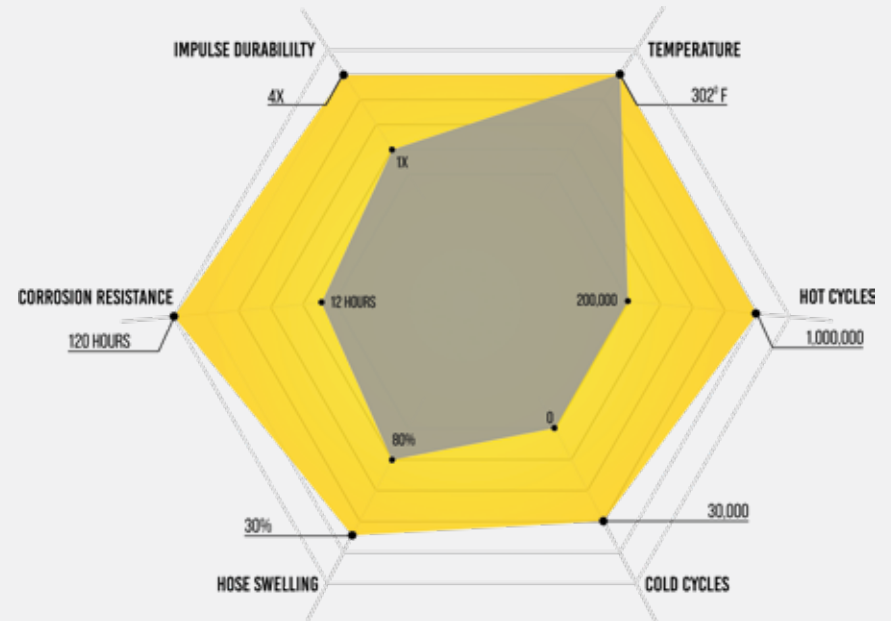

100 YEAR / 1,000,000 MILE WARRANTY



Edelmann Legacy® Power Steering Hoses



Edelmann power steering hoses are equipped with movable mounting brackets to accommodate real-world conditions under the hood. They also include heat/abrasion shields and high-temperature guards to protect the hoses from engine hot spots and exhaust system contact. Additionally, the double bead lock crimp design ensures a secure tube-to-shell connection, preventing leakage.

To cater to specific vehicle needs, Edelmann incorporates restrictors, stone guards, switch sockets, and banjo end lock tabs, adhering to OE practices. With our extensive coverage and top-notch performance, Edelmann nearly guarantees availability for any power steering hose application.



Edelmann® offers an unparalleled range of power steering hoses, boasting over 3,300 assemblies and consistent introduction of new parts, providing the widest market coverage available. Our category management team possesses over 70 years of combined experience and is reinforced by an ASE tech and an extensive online power steering parts guide, ensuring comprehensive customer support.

With our *Committed to OEM Form, Fit & Function®* philosophy, Edelmann ensures that the power steering hoses not only match but often exceed the performance of the original equipment. We meticulously replicate the physical characteristics, configurations, and features of the original hoses, such as restrictors to reduce noise and brackets for easier installation.

Edelmann employs a “Smart Consolidation” approach, where potential hose consolidations are thoroughly tested on vehicles by experienced research engineers. This guarantees that the consolidated hoses closely resemble the OE configurations in fit, routing, and features, resulting in satisfied customers.





Power Steering Repair Kits



Edelmann® Power Steering Repair Kits offer a comprehensive solution for technicians and DIY enthusiasts in the automotive aftermarket. Our repair kits are designed to include top-notch bearings, gaskets and seals made from high-quality materials for extended longevity. Parts in these kits are tailored to specific repair needs and will vary by type, encompassing essential soft parts and seals.

Our complete seal kits are equally impressive, containing PTFE seals, rubber seals, O-rings, snap rings, and washers, providing everything necessary for a thorough rebuild. Every component, from seals to O-rings, is made to OE specifications to ensure a perfect fit, streamlining the repair process.

To ensure smooth and effective repairs, all our repair kits are supplied with detailed instruction sheets. These sheets feature exploded view illustrations or service procedures, guiding the repairer through each step of the repair process.

Choose Edelmann for power steering repair solutions, trusted by industry professionals for quality, precision, and ease of use. Simplify repairs and optimize customer satisfaction with our reliable power steering repair kits, designed to meet the demands of your business and customers.



Turbocharger Oil Lines



Edelmann® meets the surging demand for turbocharged vehicles with a broad line of aftermarket turbocharger oil lines. Over one-third of vehicles now come equipped with turbochargers, and Edelmann offers an extensive range of 50 SKUs, one of the most comprehensive in the market. The oil lines cover 34 million vehicles across various applications, ensuring a wide range of compatibility with different turbocharged models. Whether for a sedan, SUV, or truck, Edelmann has it covered with our reliable and high-quality aftermarket turbocharger oil lines.

Edelmann aftermarket turbocharger oil lines boast impressive features and benefits that enhance performance and reliability.

- Complete kit with turbo feed lines, gaskets, fittings, and seals for easy installation
- High-quality fluorocarbon elastomers for durability in high-temperature environments
- High-temperature furnace brazing for tight tolerance control and strong joints
- Non-magnetic stainless steel or OE equivalent materials for added reliability
- Superior tube construction and fiberglass heat shielding for enhanced performance and oil temperature control
- Edelmann aftermarket turbocharger oil lines offer exceptional performance and confidence in meeting automotive needs.

EDELMANN ANALYTICS PROVIDES INTELLIGENCE TAILORED TO SPECIFIC NEEDS

•••••

The Edelmann Analytics program offers automated reporting tools to support sales of Edelmann® and Edelmann Elite® power steering hoses, hard parts, and coolers. These tools provide various analytics, including point-of-sale analytics at different levels (state, city, zip code, store), store and warehouse forecasting, market-specific sales analysis, and warranty analysis by part number and store.

Edelmann Analytics provides intelligence tailored to specific needs, helping customers reduce costs, drive sales, and increase customer satisfaction. We leverage a suite of dashboards and business intelligence tools to offer easy-to-digest reports and visualizations, giving insights into product sales and driving factors. Additionally, we

can assist in identifying complex repair jobs that contribute to increased warranties.

All the intelligence is housed in our data warehouse, ready to help clients drive sales and regain customer goodwill. We utilize market-specific product application and sales information to design optimal store and warehouse stocking levels, maximizing return on investment. Edelmann Analytics can provide this data across various product categories, making it a Total Solution® component for Plews & Edelmann®.

Contact us and discover how Edelmann Analytics can aid in business growth, cost reduction, and maximizing return on investment.

FACTORS WE CONSIDER

•••••

Hard Part Inventory

Territory

Popularity Rankings

Sales Data

Vehicles in Operation

Application Age

Inventory Investment

Inventory Turnover

Return on Investment

POS Data by Market

Features and Benefits



Start Here



NORTH AMERICAN SUPPLY CHAIN

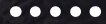

With a commitment to a North American supply chain, Plews & Edelmann® ensures a steady stream of sub-component to finished good inventory, boasting a 97% weighted order fill rate over the past two years and a supply chain that is adaptive and responsive to changes locally or abroad.

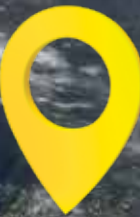
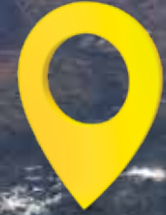
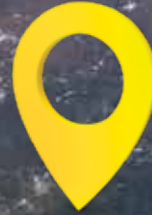

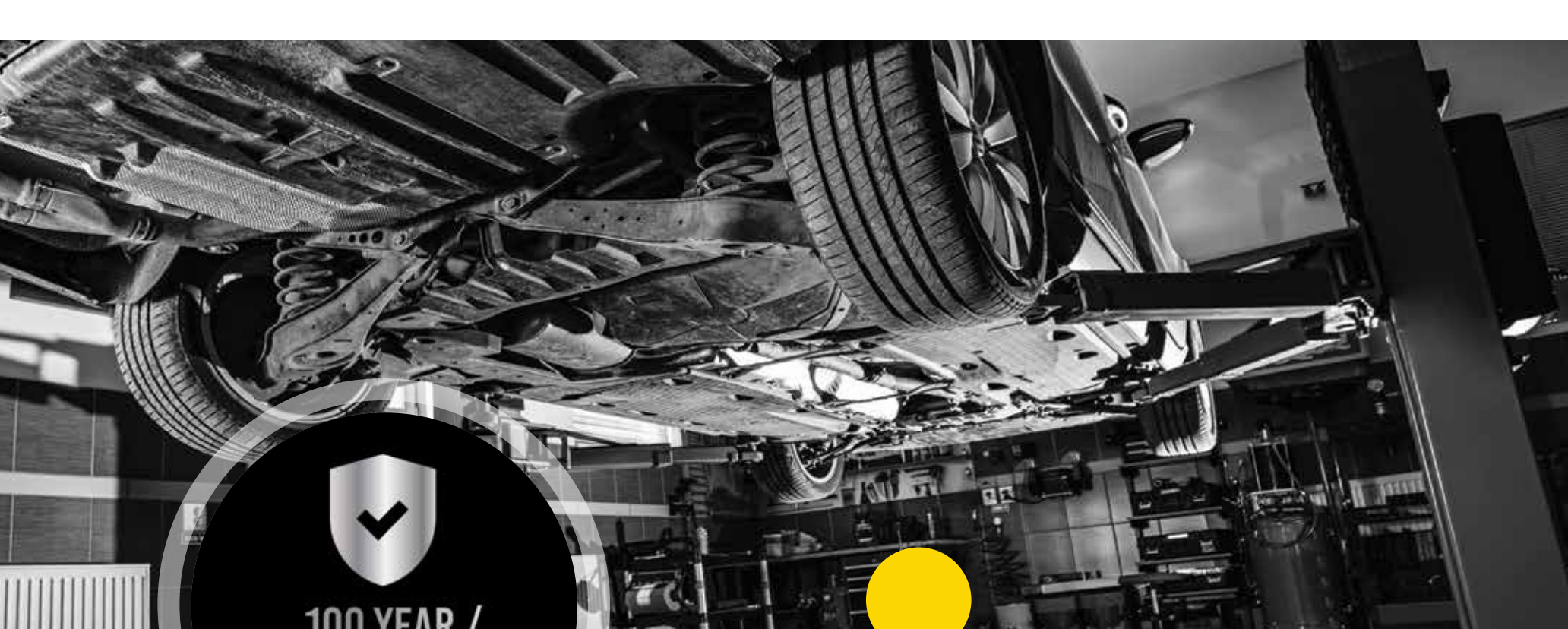

**100 YEAR /
1,000,000 MILE
WARRANTY**

NO AMBIGUOUS LANGUAGE OR LEGAL JARGON







When we say 100 years, we mean it - if our Edelmann Elite® parts are installed and maintained properly on the vehicle, we will honor the warranty for a full century. And it's not just calendar years we're talking about, but miles too - our parts are guaranteed for up to 1,000,000 miles of dependable service. No vague "lifetime" claims here, just a straightforward promise consumers can count on.

We can confidently offer this unprecedented warranty because we engineer our parts to such rigorous quality standards and durability testing that they are built to last. When someone chooses our parts, they are investing in the highest caliber manufacturing and engineering excellence. We stand behind our products that long because we can.



REDUCE ANY WARRANTY CLAIMS BY OFFERING EVERYTHING NEEDED FOR THE COMPLETE REPAIR

-  Replace the Hard Parts
-  Replace all the Hoses
-  Replace the Cooler
-  Flush and Fill the Fluid
-  Add a Filter



EDELMANN ELITE.

- High Performance Power Steering Hoses
- NEW Manufactured Power Steering Rack & Pinion Assemblies, Pumps and Gearboxes
- OE Equivalent Power Steering Coolers
- Premium Universal Power Steering Filter
- Universal Power Steering Fluid

EDELMANN®

- Legacy Power Steering Hoses
- Power Steering Repair Kits
- Electric Power Steering Repair Kits
- Turbocharger Oil Lines



ADDRESS

1550 Franklin Grove Rd
Dixon, IL 61021

PHONE & FAX

Phone 800-770-4639
Tech 855-333-5832
Fax 815-673-7019

EMAIL & WEB

Email orders@plews.com
Web plews-edelmann.com